

# ZTD | WITH 244LD LEVEL CONTROLLER

## DISPLACER LEVEL TRANSMITTER

ZTD Displacer Level Transmitter

with 244LD Level Controller

Operation Manual



## Preface

### **Thank you for choosing the products of Dandong Top Electronics Instrument (Group)Co.,Ltd.**

This operation manual provides you with important information on installation, connection and commissioning as well as on maintenance, troubleshooting and storage. Please read it carefully before installation and commissioning and keep it as part of the product near the meter for easy reading.

This manual can be downloaded by entering the version number at [www.ddtop.com](http://www.ddtop.com) .

If the instructions are not followed, the protection provided by the meter may be destroyed.

### **Trademark, Copyright and Restriction Instructions**

Dandong Top Electronics Instrument (Group) Co.,Ltd.®, Dandong Top Pump Co., Ltd.®, DDTOP® are registered trademarks of the company.

The performance specifications of the meter are effective as of the date of publication and are subject to change without notice. Dandong Top Electronics Instrument (Group)Co.,Ltd. reserves the right to modify the products described in this manual at any time without prior notice.

### **Quality Assurance**

Dandong Top Electronics Instrument (Group) Co.,Ltd. guarantees that all glass plate level gauge have no defects in materials and manufacturing processes within one year from the date of delivery.

During the warranty period, if the product returns with quality problems and the claim is determined by the manufacturer to be within the scope of warranty, Dandong Top Electronics Instrument (Group) Co.,Ltd. is responsible for repair or replacement of the buyer (or owner) free of charge.

Dandong Top Electronics Instrument (Group) Co.,Ltd. is not responsible for the costs caused by improper use of equipment, labor claims, direct or subsequent damage and installation and use of equipment. In addition to the special written warranty certificate for certain products of Dandong Top Electronics Instrument (Group) Co.,Ltd., Dandong Top Electronics Instrument (Group) Co.,Ltd. does not provide any express or implied warranty.

### **Quality**

Dandong Top Electronics Instrument (Group) Co.,Ltd. has passed the ISO9001 quality system certification. The whole process of product production is strictly in accordance with the scope of the quality system, providing the strongest guarantee for product and service quality.

**CONTENTS**

1 Safety Tips .....	4
1.1 Explosion may result in death or serious injury.....	4
1.2 Process leaks can cause serious injury or death.....	4
1.3 Failure to follow safe installation guidelines may result in death or serious injury.....	4
2 Product Manual .....	4
2.1 Main Structure of Product-Figure 1 .....	4
2.2 Operating Principle .....	5
2.3 Packing.....	5
2.4 Hoisting and Transporting.....	5
2.5 Warehousing .....	5
3 Technical Characteristics.....	5
3.1 Main Performance .....	5
3.2 Main Parameters.....	6
4 Dimensional Schematic -Figure 2 .....	6
5 Unpacking and Inspection .....	6
5.1 Unpacking Inspection Notice.....	6
5.2 Check Content .....	7
6 Installation .....	7
6.1 Installation Tool.....	7
6.2 Installation Requirements .....	8
6.3 Installation Operation Process.....	9
7 Debugging .....	11
7.1.1 Debugging Tool.....	11
7.2 Electrical Wiring.....	11
7.3 Debugging Operation Process.....	12
8 Recautions .....	26
9 Failure Analysis and Elimination.....	27
10 Disassembly.....	29
10.1 Warning.....	29
10.2 Waste Removal .....	29
11 Product Certification.....	29

## 1 Safety Tips

It is expressly prohibited to modify or change products for safety reasons, repair or replacement only allows the use of accessories specified by the manufacturer.

### 1.1 Explosion may result in death or serious injury.

When installing equipment in an explosive atmosphere, be sure to follow applicable local, national, international standards, codes, and procedures. Be sure to install the equipment in Intrinsically safe or non-flammable site operating procedures.

### 1.2 Process leaks can cause serious injury or death.

Care should be taken to lift the transmitter. If the process seal is damaged, the medium may leak at the joint.

### 1.3 Failure to follow safe installation guidelines may result in death or serious injury.

The operations described in this manual are performed by professionally trained and qualified professionals or end-user specialized professionals to complete.

## 2 Product Manual

### 2.1 Main Structure of Product-Figure 1

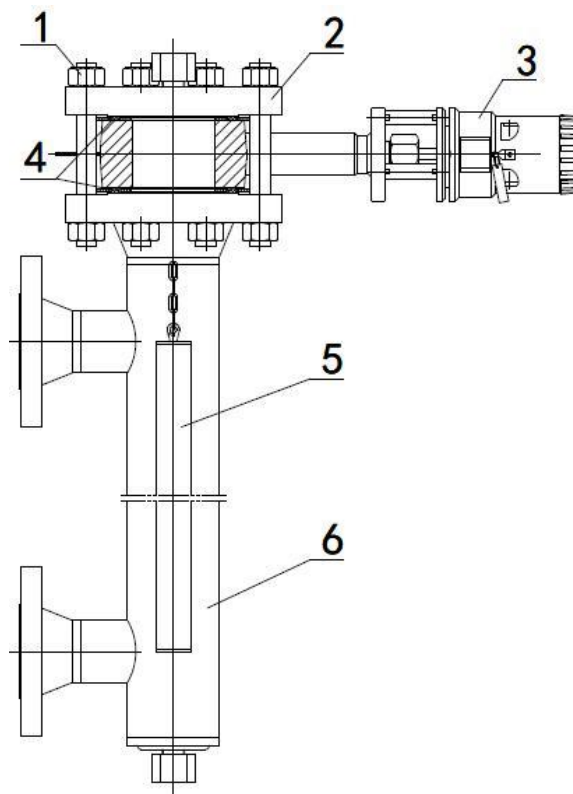

Figure 1 Product Structure

1. Fasteners, including bolt and nut washers
2. Flange cover, can be equipped with venting parts according to user requirements
3. Transmitter, 360° rotation, 8 viewing positions
4. Seal, two pieces
5. Displacer, buoyancy measuring element
6. Chamber

## 2.2 Operating Principle

The buoyancy of displacer is transmitted to the sensor 3 via lever 1 and the torque tube. In measuring range, the voltage is proportional to the buoyancy, and as the input signal is transmitted to the electronic amplifier. Through the electronic amplifier, voltage is converted to 4-20 mA two-wires output signal.

Any part of the float immersed in liquid obeys Archimedes' principle of buoyancy. By measuring the change in buoyancy of a cylindrical float suspended in a liquid, the level, interface or density of the liquid can be measured.

When measuring the density and interface level, the displacer should be completely immersed in liquid. The change of the liquid level must be within the range.

## 2.3 Packing

Please send the packaging waste to a special recycling agency.

## 2.4 Hoisting and Transporting

Please select qualified hoisting equipment and lifting straps, and pay attention to safety.

## 2.5 Warehousing

Storage temperature -20°C~40°C; storage humidity ≤40%

# 3 Technical Characteristics

## 3.1 Main Performance

### 3.1.1 Explosion proof certification mark

Intrinsically safe type Ex iaIICT4/6

Explosion-proof type Ex dIICT4/6

### 3.1.2 Product executive standards

GB/T13969 Float Type Level Meter

Q/AMM 013 Float Level Transmitter.

### 3.2 Main Parameters

3.2.1 Power supply: 12~30V DC; reverse polarity protection in the controller (controller voltage  $\geq 17.75$  V DC when HART protocol communication).

3.2.2 Output signal: 4 ~ 20mA DC.

### 4 Dimensional Schematic -Figure 2

If the order is required to be a special size, the actual size will prevail.

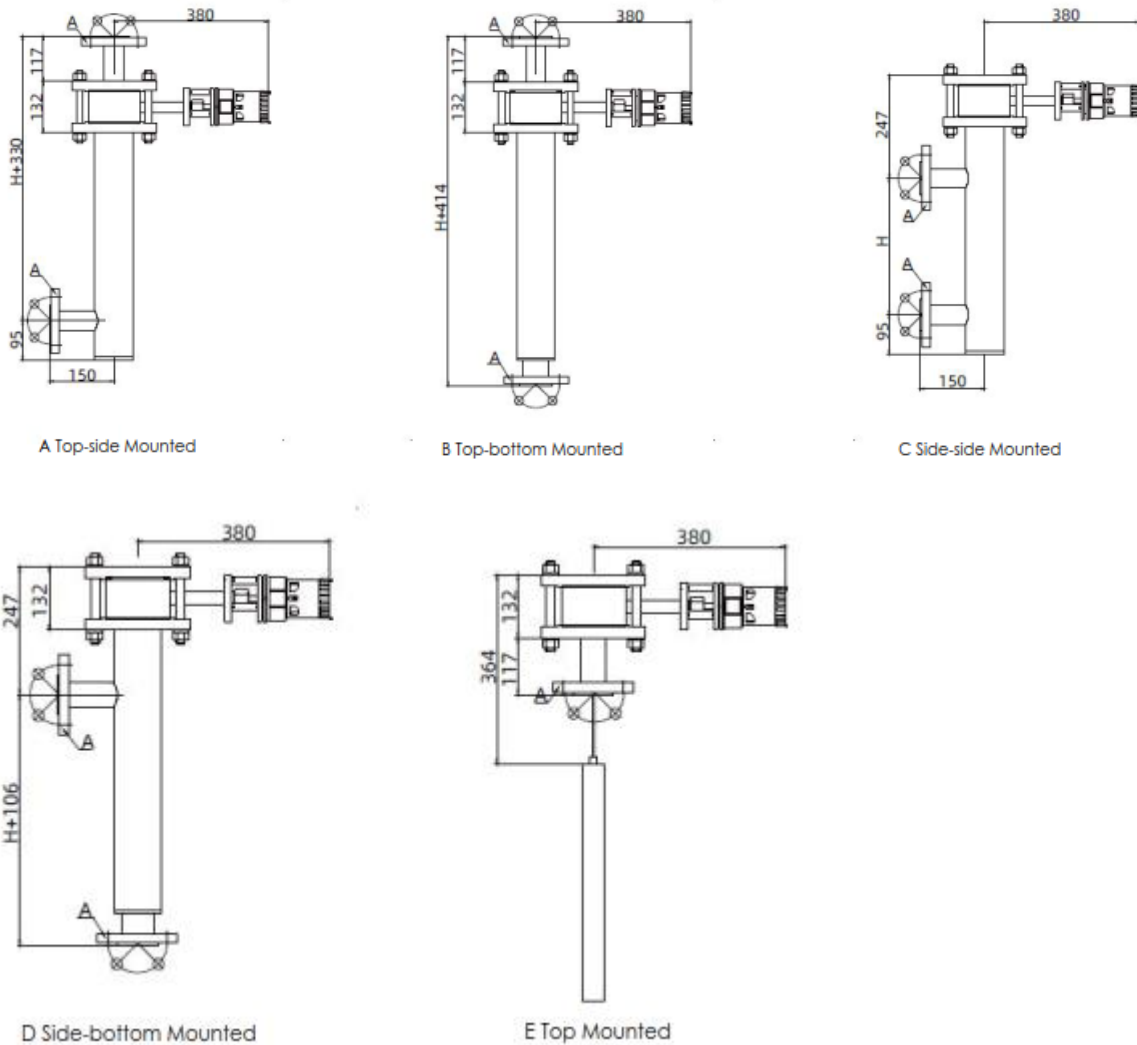

Figure 2

### 5 Unpacking and Inspection

#### 5.1 Unpacking Inspection Notice

5.1.1 Check whether the product nameplate (Figure 3) is consistent with the supply list information.

○ Displacer Level Transmitter ○  
Model:

Nominal Pressure		Design Temperature	≤	°C
Range	mm	Float Diameter	Φ	mm
Float Weight	Kg	Output Signal	(4~20) mA+Hart	
Light Medium Density		g/m <sup>3</sup>	<input checked="" type="checkbox"/>	Ex ia II CT4 / T6 Ga
Heavy Medium Density		g/m <sup>3</sup>	<input checked="" type="checkbox"/>	Ex d II CT4 / T6 Gb
Accuracy		IP66	Tag No.	
Date / Number of Manufacture		/		

○ Dandong Top Electronics Instrument (Group) Co.,Ltd. ○

Figure 3 Product Nameplate

5.1.2 According to the packing list, check the quantity of each part and the material is correct.

## 5.2 Check Content

5.2.1 Check the appearance of the instrument for defects, damage and other abnormal conditions.

5.2.2 If the ZTD transmitter and other parts are packaged separately, before installing the inner cylinder, please remove the two damping rubber rings on the inner cylinder (Figure 4).

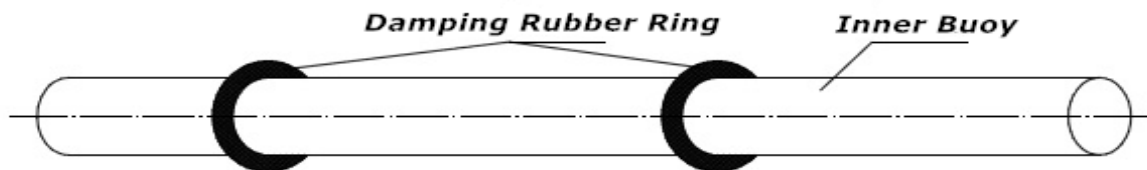

Figure 4 Damping Rubber Ring

## 6 Installation

### 6.1 Installation Tool

6.1.1 Wrenches, flange gaskets and flange bolts for process connections.

6.1.2 Level

## 6.2 Installation Requirements

6.2.1 When installing the measuring chamber, the axis of the outer cylinder side flange must be perpendicular to the horizontal plane (Figure 5). If the ZTD transmitter and the remaining parts are packaged separately, install the parts according to the position shown in Figure 1. If it has been installed as a whole, follow 6.2.3-5.

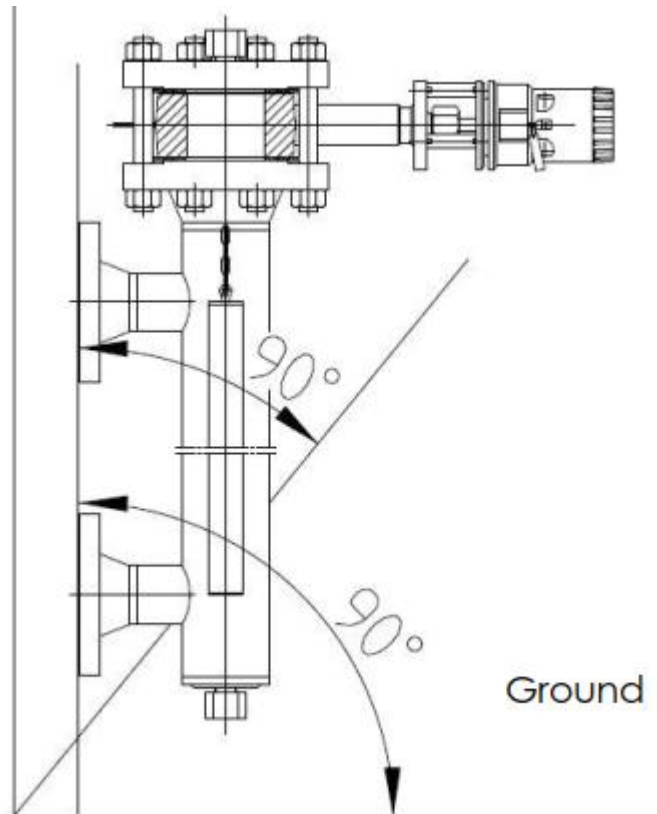

Figure 5

6.2.2 There are two cases depending on how the in-field float connector is connected, see figure below.

(1) Hook locking connector: Use the hand holding the connector on the inner tube pull ring (Figure 6), the connector set into the top of the transmitter lever, and then turn the pull ring to the locking position, the inner tube is locked on the lever (Figure 7).



Figure 6 Unlocked State





Figure 7 Blocked State

(2) Pegboard spring type connector: When installing the inner tube, the lever enters from the entrance end, and then moves to the fixed end with your finger through the spring. (Figure 8)

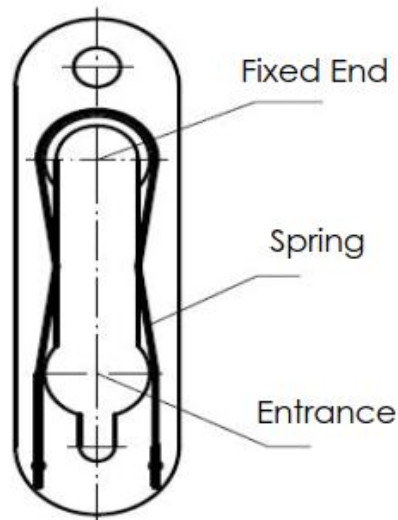
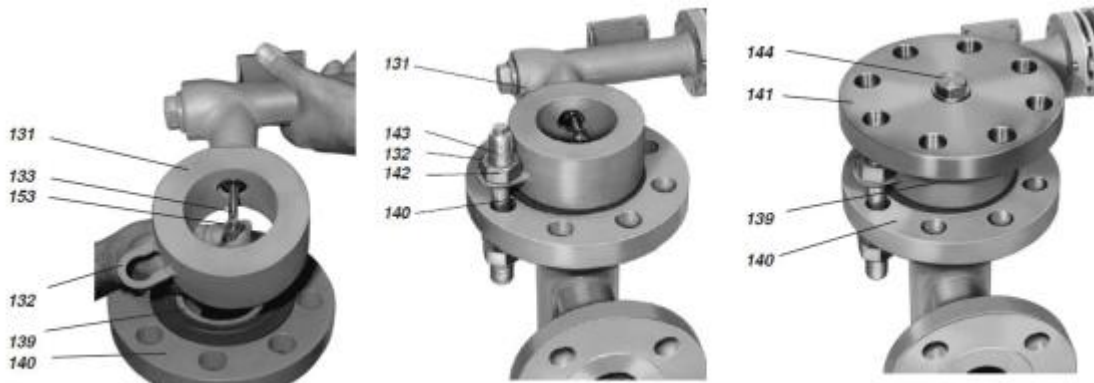
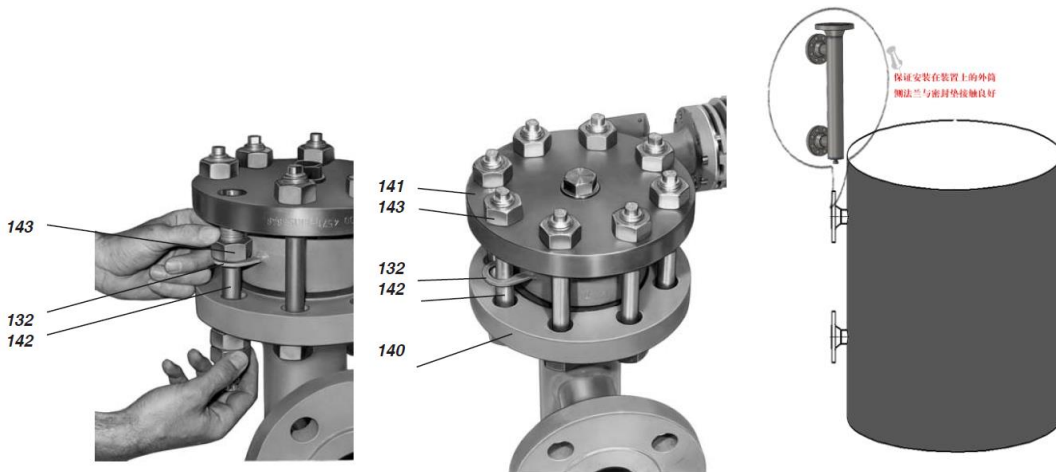
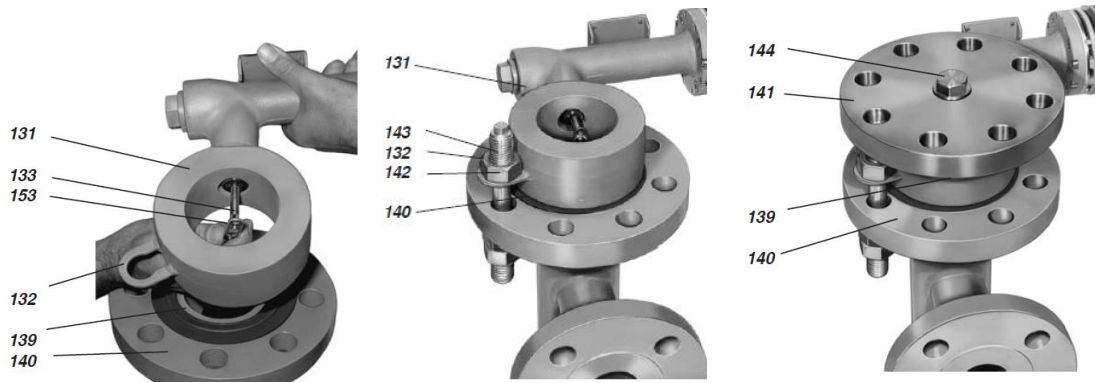

Figure 8

### 6.3 Installation Operation Process

Place the gasket 139 on the interface flange 140 and insert the float into the float chamber or container. Maintain 244LD transmitter 131 positioned above the connection flange. Suspend the float connector 153 on the lever 133 and install the transmitter on the connection flange. (Take care not to throw the float downward to avoid impact loads.) To facilitate installation, first attach the mounting bracket 132 to the connection flange 140 with studs 142. It is recommended to first tighten the nut 142 with the pre-installed 1 stud 143 via a threaded connection, then thread this stud from the top of the mounting bracket through the mounting bracket and the connection flange, and screw in a sufficient number of females from the bottom of the connection flange and hold in place. Install gasket 139 over the holding ring flange, mount the blind flange 141 on the holding ring flange and ensure that the blind flange is aligned with the threaded holes in the connection flange. Install in the remaining nut and gently tighten the nut. Loosen the nut 143 and remove the stud. Install the outer cylinder side flanges on the unit, needing to ensure that the flanges are in good contact with the gasket. See Figure 9.



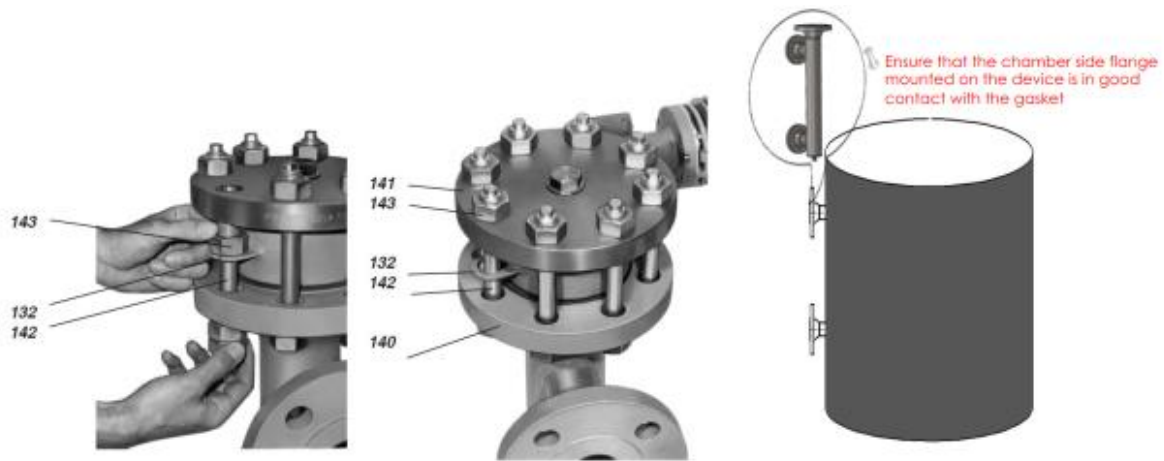

Figure 9

## 7 Debugging

### 7.1.1 Debugging Tool

- 1) Power supply
- 2) 250Ω-1100Ω resistors for HART communication protocol
- 3) Communicator supporting HART protocol (Rosemount 275, 375, 475)

### 7.2 Electrical Wiring

7.2.1 Open lid lock 24 (if provided) and unscrew lid 22. wires are connected to terminals 45, 46, 47 via wire sealing tube. Care must be taken to install the wire seal tube. Unscrew cover 22 and install cover lock 24. connect additional ground terminal 48 if required, see Figure 10.

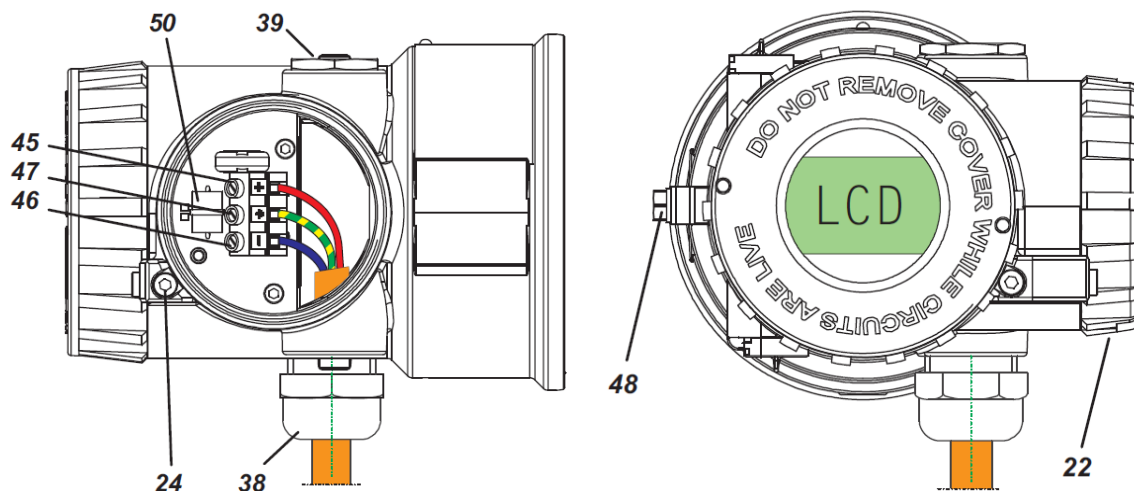

- 22 Power connection chamber cover
- 24 Cap lock
- 38 Wire seal (allowable wire diameter 6-12 mm)
- 39 Plugs

- 45 Connecting terminals+
- 46 Connecting terminals -
- 47 Ground terminal
- 48 Additional ground terminal
- 50 Overvoltage protection devices

7.2.2 After the wiring is completed, check the polarity of the wiring correctly. The instrument case must be well grounded, and then the 24VDC standard power supply is turned on.

7.2.3 When communicating with HART protocol, the power supply voltage of the intelligent liquid level controller must be  $\geq 17.75\text{VDC}$ . If it is lower than this voltage, the configuration information will be considered incorrect.

7.2.4 A resistance of  $250\ \Omega \sim 1100\ \Omega$  must be connected in the loop to communicate with the HART communicator.

### 7.3 Debugging Operation Process

#### 7.3.1 Precautions before Commissioning

- 1) The instrument should not be subjected to strong vibration and shock, especially for the lever with the inner cylinder, and should not be pulled hard to avoid damage to the torque tube.
- 2) The instrument shall not participate in impactful process tests such as air sweeps performed before the device is put into production.

7.3.2 During commissioning, if water is used as the medium (non-measured medium), the following two conditions will occur:

$\rho_{\text{medium}} < \rho_{\text{water}}$  and  $\rho_{\text{medium}} > \rho_{\text{water}}$ . But regardless of the density of the medium, you can pass the formula:

$h_{\text{Water injection height}} = \rho_{\text{medium}} \cdot H_{\text{full scale height}} / \rho_{\text{water}}$  Calculate the corresponding water injection height and the corresponding output current value.

**※The meter has been calibrated before leaving the factory.**

#### 7.3.3 Key Debugging

By order, the operating parameters are stored in the transmitter. If the actual operating data deviates from the order, a recalibration is required.

To begin operation: turn on the power, the Foxboro Eckardt abbreviated marker appears, and then the device information appears, see Figure 11.

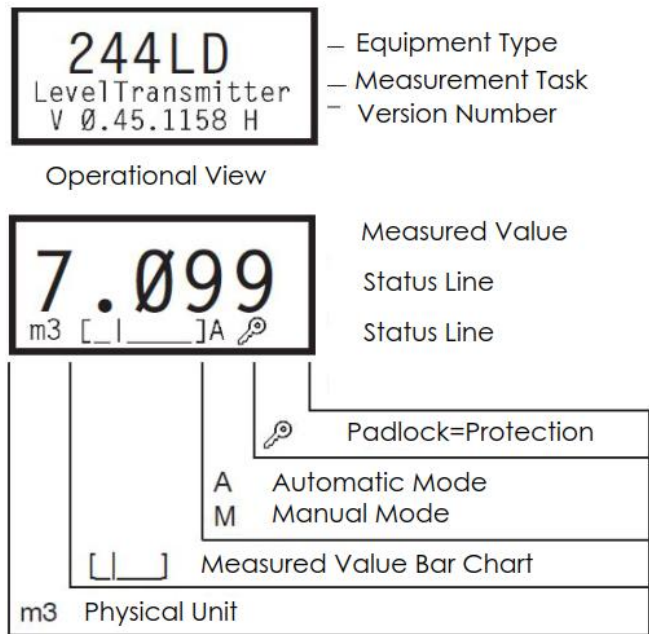

In normal operating mode, the display looks like this

Figure 11

1) Field key debugging: through the local key and LCD setting

As shown in Figure 12, operating parameters and settings can be displayed in the field and in the event of a change in circumstances, and in the absence of other controls inside the unit, local operation can be performed using a complete LCD chart and buttons on the outside of the housing.

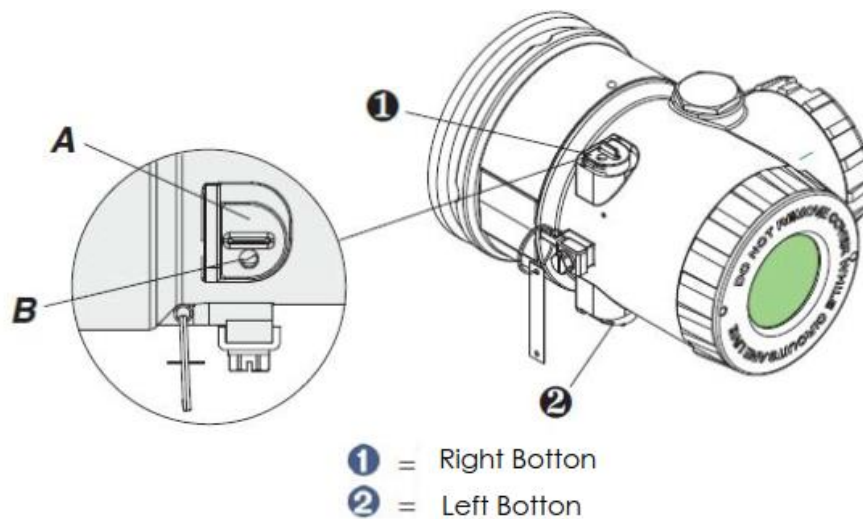

Figure 12

After raising the protection key A, insert a screwdriver or pin ( $\leq 3\text{mm}$  diameter) in hole B and press down to contact the pressure point.

Starting from the operation view, press ② to toggle operation specific items; press ① to toggle options in the main menu, as detailed in Figure 13. If no key is pressed within 5 minutes, the display will automatically return to the operation screen.

## 2) Change the range

### Linear Adjustment

Generally used for level compensation, damping and LCD comparison. The current measured value is displayed, and the value increases when the ② key is pressed several times. When the maximum value is reached, pressing the key again will return to the minimum value. The key has an automatic repeat function. Pressing ① completes the stop action and saves the search and change process.

### Numerical Calibration

Normally used for measuring range values: The current value is displayed and the first digit or signal is selected. Each time ① is pressed, the value is incremented until it reaches the desired value. When ② is pressed, the value is adjusted to the next value and the change is made in sequence. The search and change process is then saved.

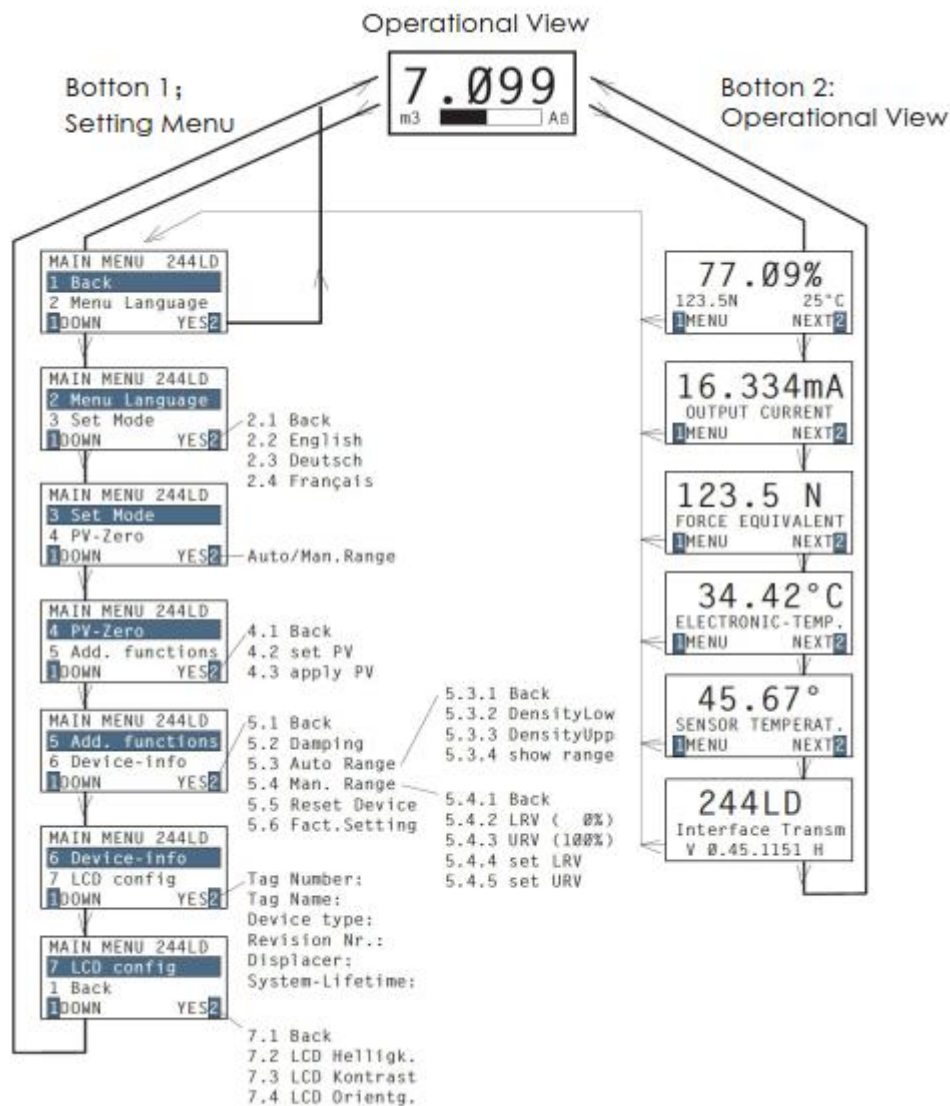

Figure 13

The specific functions of the operation are as follows:



Back to the operation interface

When YES ② is selected, you will be returned to the operation interface.



**Note:** All drop-down menus start with "Back", a feature that allows you to go back to the previous menu. This feature allows you to go back to the previous menu. It is easier to describe.



Enter language selection with the YES key.

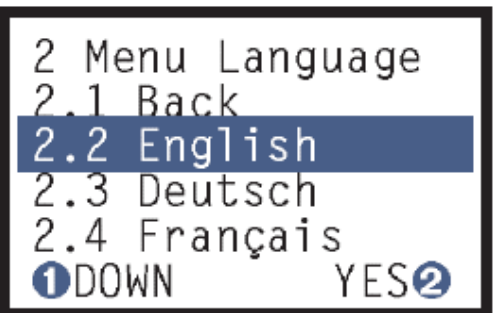
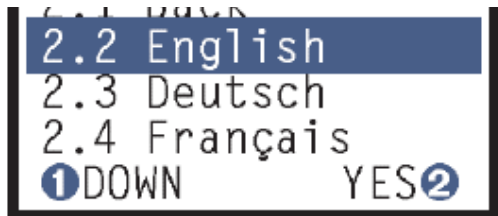

Menu 2 Menu Language

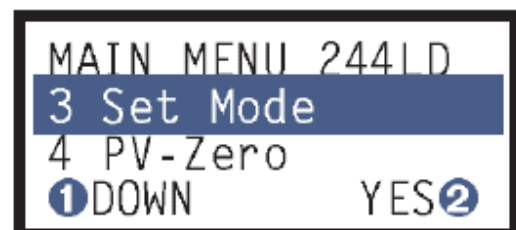

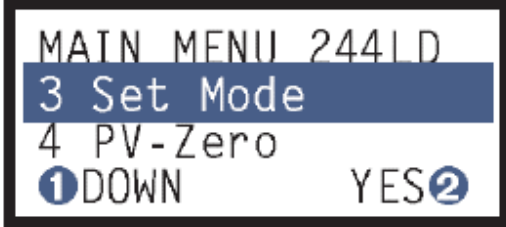

Press ② button to enter auto-manual mode selection.

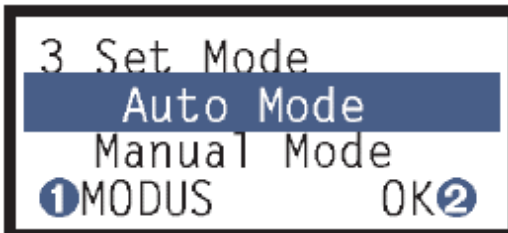
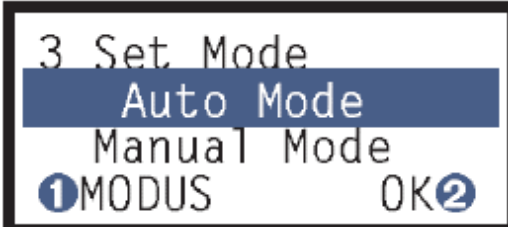

Menu 3 Setting Mode

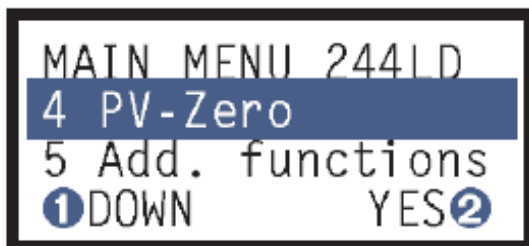
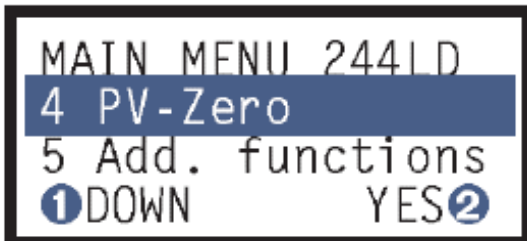

Press ② to enter level offset setting.

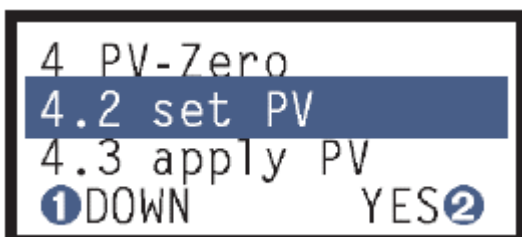



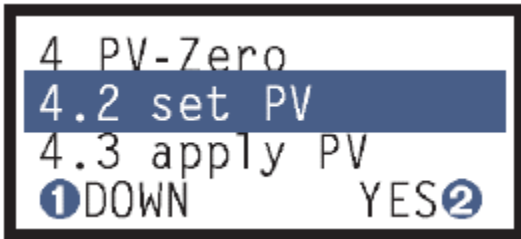

Press ② to set the level offset in either automatic or manual mode.

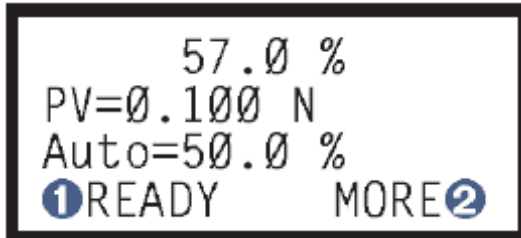

Set the linear calibration within 0.1% increments.

The effect of the change in expectation can be shown in the second line of the initial change.

The results of the automatic level shift calibration can be displayed in the third row to observe the change in value and return to the previous value.

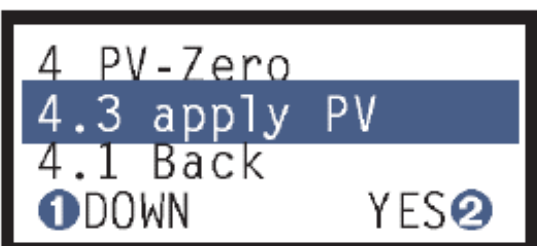
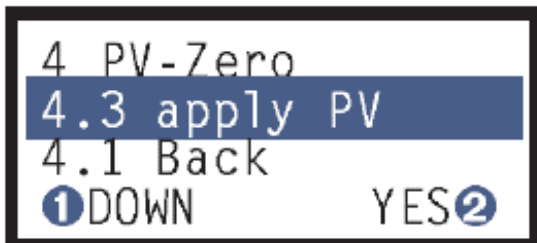
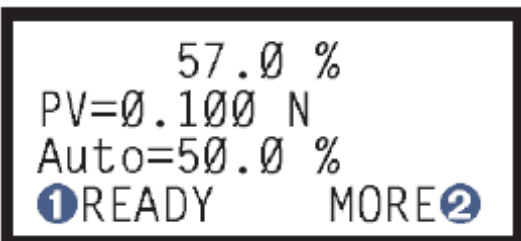

The current process value (level: the float is not in the medium) will be received as a physical 0 point by pressing the YES ② key. This menu item is only used in manual mode and the automatic mode will be locked (padlock mark displayed).

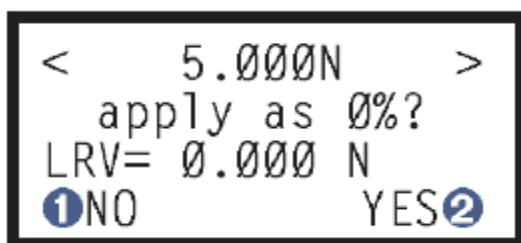

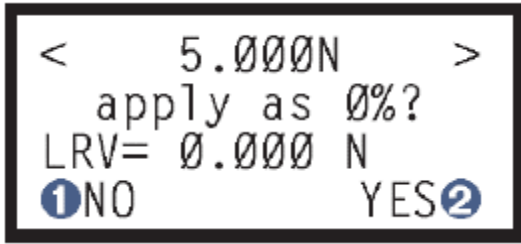

Menu 4 Setting Level Offset

Press ② to confirm, and the current value will be saved as the lower limit value of the liquid level.



按 YES②键进入下拉菜单



Press the YES key to enter the drop-down menu.



Press YES ② to set the damping time.





The current value is displayed first.

The value is corrected by pressing the ② key and adjusted for 1 second each time, see section "Linear Adjustment".

Then return to the menu.

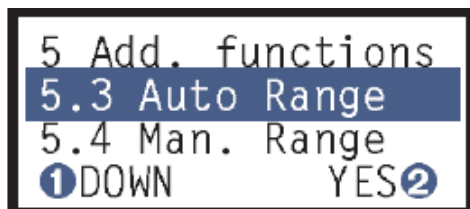
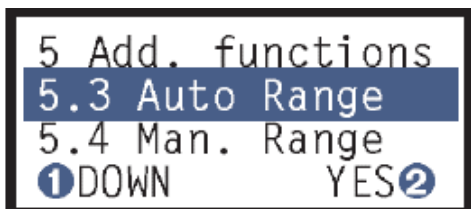

Press the YES key to set the range setting in auto mode.

The density can be changed in the automatic mode and is taken into account in the automatic calculation.

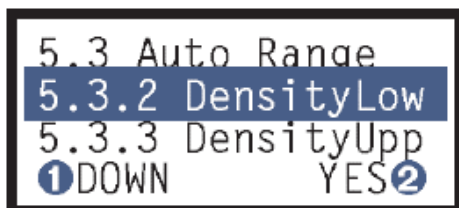

Press the YES key to enter the "Lower Media Density" setting.

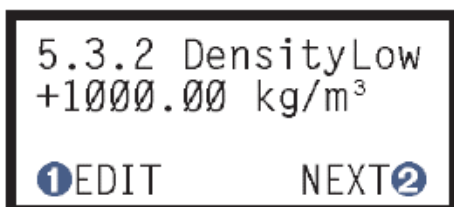
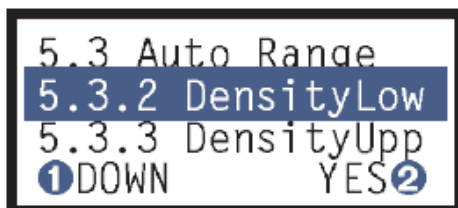

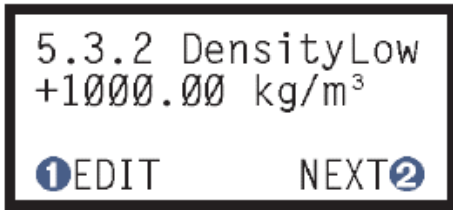

Enter this value using the "Value Calibration" option.

This value must be finalized and saved.

If the density of the bottom media is lighter than the density of the top media, an error message will appear and the value will not be saved.

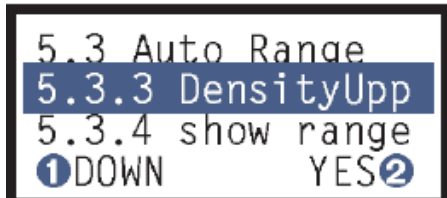

Press the YES key to enter the "Upper Media Density" setting.

(The setting process is the same as for the bottom media density.)

**Note: This value is 0 for the measured liquid level.**

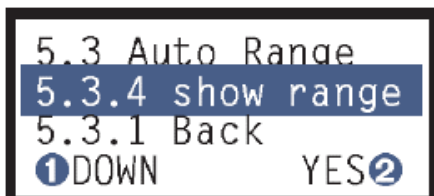
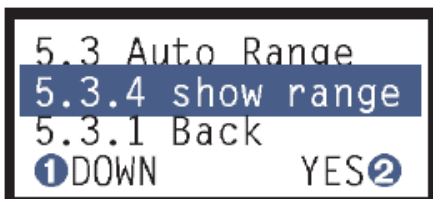
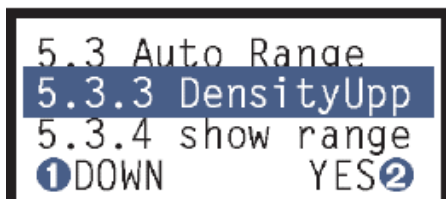

Press the YES key to display the current measurement range.

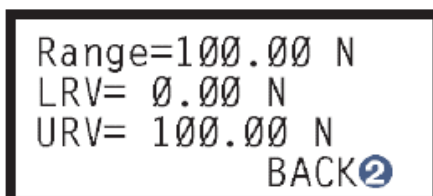

Measuring range

lower limit of span

upper limit of span

Press ② to return to the previous menu.

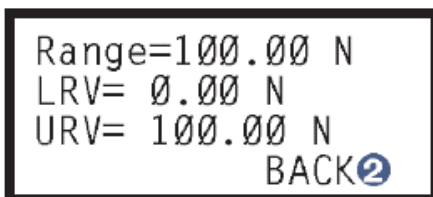



Press the YES key to enter "Manual Mode Range Setting".

The amount of buoyancy change is received each time the operating condition is set to 0% (level value when the cylinder is empty) or 100% (level value when full scale). Alternatively, the value entered can be used to make the change within the 0% and 100% range.

**Note:** This feature is only available in manual mode, automatic mode is in the locked position (padlock symbol on LCD).

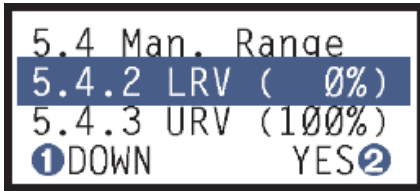
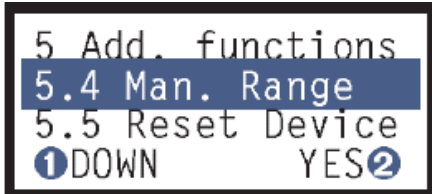

LRV - Lower Limit of Receiving Range (0%)

Press the YES (2) key to display the following.

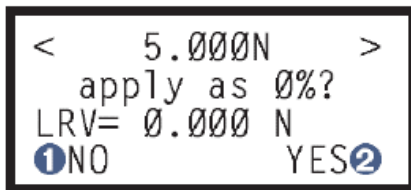
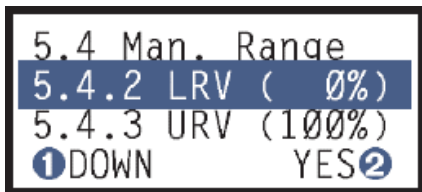

The current measurement value is saved as the lower limit of the measuring range using the YES key.

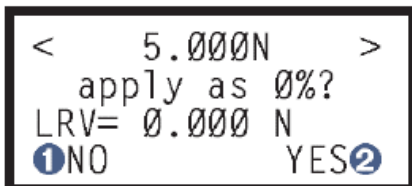

```
5.4 Man. Range
5.4.3 URV (100%)
5.4.4 set LRV
①DOWN      YES②
```

```
5.4 Man. Range
5.4.3 URV (100%)
5.4.4 set LRV
①DOWN      YES②
```

```
5.4 Man. Range
5.4.4 set LRV
5.4.5 set URV
①DOWN      YES②
```

```
5.4 Man. Range
5.4.4 set LRV
5.4.5 set URV
①DOWN      YES②
```

```
5.4.4 set LRV
+010.000 %
min= 000.000 %
①EDIT      NEXT②
```

```
5.4.4 set LRV
+010.000 %
min= 000.000 %
①EDIT      NEXT②
```

```
5.4 Man. Range
5.4.5 set URV
5.4.1 Back
①DOWN      YES②
```

URV-Receive upper limit of range (100%)  
(Set lower limit of same range for process)

LRV-Confirm lower limit of range (0%)

Press the YES ② key to display the following.

Confirm this value using "Value adjustment".

In the third row, the minimum value is displayed.

Finally, this value must be acknowledged and saved as the lower limit of the range.

URV - Confirmation of upper range limit (100%)  
(Set the upper limit of the same range as the process.)



Press the YES key to enter the function option.  
After further confirmation, the electronic reset function starts the same function as turning on the power.

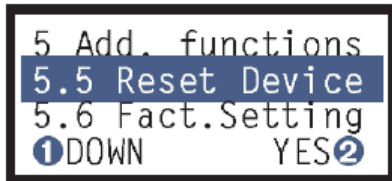
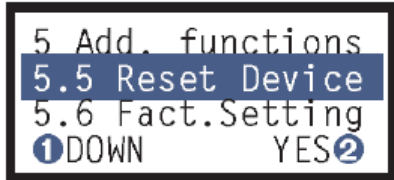

Press the YES ② key to enter the function options.  
WARNING: All user settings will be lost and returned to the factory default settings by further confirmation.

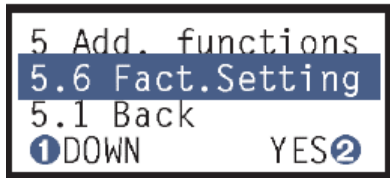

YES ② key displays the data stored in the transmitter.

For example, the place code

- Bit number name
- Type of equipment
- Manufacturer's number
- Float Data
- System life cycle

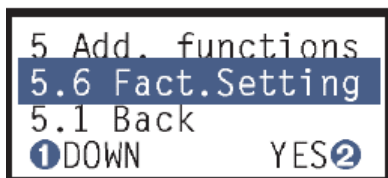

### Menu 5 Additional Function



### Menu 6 Device Information





Press the YES key to enter the LCD setting.

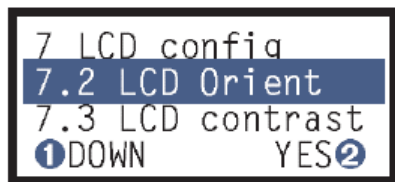

Press the YES key to enter the LCD orientation option.

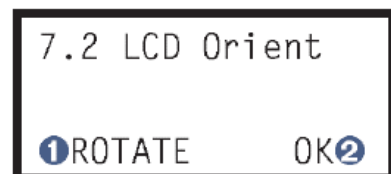
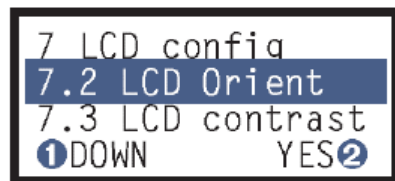

Press the ROTATE ① key at the bottom of the text footer.

Press OK to confirm the return menu.

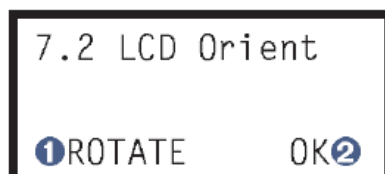





Press the YES key to set the contrast of the LCD.  
Linear settings.

Menu 7 LCD Display Configuration

#### Key Debugging Quick Key Sequence

Function	Quick key sequence
Set manual mode	1-1-1-2-1-2-2
Set PV-Zero	1-1-1-1-2
Set Damping	1-1-1-1-1-2-1-2
LRV(0%)	1-1-1-1-1-2-1-1-1-2-1-2-2
URV(100%)	1-1-1-1-1-2-1-1-1-2-1-1-2-2
Set LRV	1-1-1-1-1-2-1-1-1-2-1-1-1-2
Set URV	1-1-1-1-1-2-1-1-1-2-1-1-1-1-2
Device-info	1-1-1-1-1-1-2

#### 7.3.4 Handheld Debugging

The handheld debugging steps are shown in the figure below

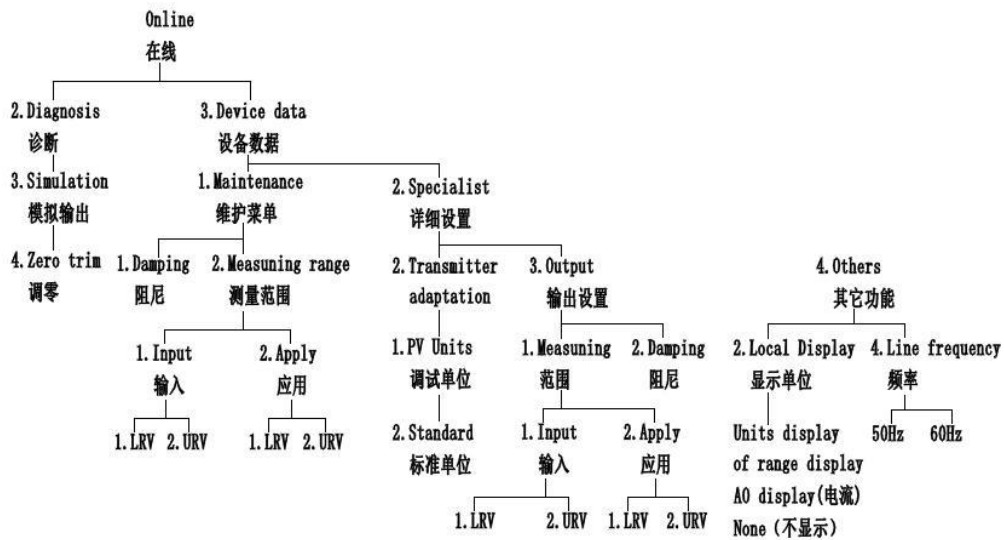

### Model 475 HART Communicator Quick Key Sequence

Function	Quick key sequence
Simple calibration: set LRV	3-2-3-1-2-1 或 3-1-2-1-1
Simple calibration: set URV	3-2-3-1-2-2 或 3-1-2-1-2
Set Damping	3-2-3-2
Set the LCD	3-2-6-2
Set the measurement mission	3-2-2-2
Set PV unit	3-2-2-1-2
Set tags.	3-2-1-1
Set descriptors	3-2-1-2
Set date	3-2-1-3

After completing the above operation, the level transmitter can be used.

**\* Pay special attention to the unity of the measurement unit when setting.**

## 8 Recautions

8.1 The density of use should be the same as the design density. If the density changes, the parameters need to be changed again to calibrate the instrument

8.2 During the disassembly and assembly process, the torsion tube should be protected as much as possible to prevent damage to the force;

8.3 Make sure the power supply is safe and reliable, and the power supply should be connected according to the correct positive and negative poles;

8.4 Do not operate the instrument with an unsupported handheld communicator;

8.5 When the vibration is large, it is not suitable to use the displacer level transmitter;

8.6 Medium with viscosity  $\geq 500\text{mPa/s}$  is not suitable for measurement with a displacer level transmitter;

8.7 The operating temperature range of electronic components is  $-40\text{ }^{\circ}\text{C} \sim +80\text{ }^{\circ}\text{C}$ , the temperature range displayed on the LCD screen is  $-30\text{ }^{\circ}\text{C} \sim +80\text{ }^{\circ}\text{C}$  (out of range LCD display, remote transmission is normal);

8.8 After the commissioning, tighten the display and power cover to prevent the instrument from getting wet.

## 9 Failure Analysis and Elimination

Phenomenon	Reason	Solution
After power-on, the LCD has no display, no signal output	<ol style="list-style-type: none"> <li>1. The power supply polarity is reversed or the power supply is faulty;</li> <li>2. There is an open circuit in the line.</li> </ol>	<ol style="list-style-type: none"> <li>1. Check if the power supply voltage is normal, and check if the power supply circuit has an open circuit;</li> <li>2. If there is a safety barrier in the circuit, check if the safety barrier is working properly;</li> <li>3. Connect the positive and negative power supplies correctly.</li> </ol>
The actual level of the device changes, and the meter indication and output do not change with the level, or the variation range is inconsistent.	<ol style="list-style-type: none"> <li>1. The inner cylinder anti-vibration rubber ring is not removed, and friction occurs with the outer cylinder wall;</li> <li>2. The inner cylinder or lever is caught by the foreign object;</li> <li>3. The outer cylinder is installed without vertical friction with the inner cylinder;</li> <li>4. The inner tube connector is reversed, and the inner tube is rubbed against the outer tube wall;</li> <li>5. The locking device of the transmitter is not pushed to the unlocked position.</li> </ol>	<ol style="list-style-type: none"> <li>1. In the process of transportation, in order to prevent collision damage of the inner and outer cylinders, the inner cylinder will be installed with anti-vibration rubber ring when the factory is shipped, and the rubber ring should be taken out during the installation process;</li> <li>2. Check if there is any foreign matter in the inner cylinder and the lever, and remove the foreign matter;</li> <li>3. Correct the outer cylinder to be perpendicular to the ground;</li> <li>4. Re-install the inner cylinder correctly;</li> <li>5. Push the locking device to the unlocked position. (in the direction of the arrow)</li> </ol>
The meter displays the output maximum or over range, and there is no change in the commissioning, and there is no change in the field indication.	<ol style="list-style-type: none"> <li>1. The inner cylinder is detached;</li> <li>2. The instrument junction box is faulty;</li> <li>3. The locking device of the transmitter is not pushed to the unlocked position.</li> </ol>	<ol style="list-style-type: none"> <li>1. Connect the inner tube</li> <li>2. Replace the junction box</li> <li>3. Push the locking device to the unlock position</li> </ol>

<p>After the meter is calibrated, it is put into use and there is a deviation from the actual level value. The indication is not allowed.</p>	<ol style="list-style-type: none"> <li>1. The process parameters are not accurate (the actual density is inconsistent with the design density);</li> <li>2. On-site heating causes the density of the medium to change;</li> <li>3. Local indication level indicator is not accurate.</li> </ol>	<ol style="list-style-type: none"> <li>1. Re-determine the process parameters, recalibrate the meter at the new density, or modify the meter display and output using the fixed-point migration function.</li> <li>2. Adjust the temperature of the heating to prevent the density of the measured medium from changing;</li> <li>3. Check the local level gauge to determine its accurate reflection of the actual level.</li> </ol>
<p>Tuning instrument is not linear, and has a large difference.</p>	<ol style="list-style-type: none"> <li>1. The inner tube is stuck by debris, and the range cannot be opened.</li> <li>2. The inner cylinder anti-vibration rubber ring is not removed.</li> <li>3. The power supply voltage is abnormal.</li> <li>4. Parameter calculation error during verification</li> <li>5. The locking device of the transmitter is not pushed to the unlock position.</li> </ol>	<ol style="list-style-type: none"> <li>1. Remove debris</li> <li>2. Take out the rubber ring</li> <li>3. Adjust the power supply voltage</li> <li>4. Recalculate the correct parameters.</li> <li>5. Push the locking device to the unlock position</li> </ol>
<p>The header shows garbled characters and the output signal does not change.</p>	<ol style="list-style-type: none"> <li>1. The circuit board is faulty;</li> <li>2. The power supply voltage is abnormal.</li> </ol>	<ol style="list-style-type: none"> <li>1. Replace the meter head;</li> <li>2. Detect the power supply replacement barrier.</li> </ol>
<p>When the meter is adjusted, the output current of the meter is high or low.</p>	<ol style="list-style-type: none"> <li>1. Power failure;</li> <li>2. The meter insulation is not good.</li> </ol>	<ol style="list-style-type: none"> <li>1. Check the power supply and replace the safety barrier;</li> <li>2. Detect the insulation of the meter terminals. If there is any problem with the insulation, replace the meter head.</li> </ol>
<p>The LCD display percentage and level value do not match the actual output current value.</p>	<ol style="list-style-type: none"> <li>1. URV and LRV input errors;</li> <li>2. The instrument is not calibrated with a regular hand-held device, resulting in a digital signal that does not match the analog signal.</li> </ol>	<ol style="list-style-type: none"> <li>1. Re-enter the URV and LRV values (URV=range; LRV=zero).</li> <li>2. Calibrate the current using the Communicator Modulo Calibration function.</li> </ol>
<p>The meter displays 0%; the level changes and the meter output do not change.</p>	<ol style="list-style-type: none"> <li>1. The meter parameter density value becomes "0";</li> <li>2. Instrument parameter torque tube stiffness is "0";</li> <li>3. The locking device of the transmitter is not pushed to the unlock position;</li> <li>4. The inner cylinder is detached or the anti-vibration rubber ring is not taken out.</li> </ol>	<ol style="list-style-type: none"> <li>1. Re-enter the correct density value;</li> <li>2. Re-enter the torque tube stiffness value 8-30, and re-calibrate the instrument at two points;</li> <li>3. Push the locking device to the unlocked position;</li> <li>4. Reinstall the inner cylinder or remove the anti-vibration rubber ring.</li> </ol>
<p>The meter output continues to decrease and cannot be properly calibrated.</p>	<ol style="list-style-type: none"> <li>1. Torque tube failure;</li> <li>2. The inner cylinder is smashed, leaked, and fed into the medium.</li> </ol>	<ol style="list-style-type: none"> <li>1. Replace the torque tube;</li> <li>2. Replace the inner buoy</li> </ol>

<p>The Communicator is not communicating.</p>	<ol style="list-style-type: none"> <li>1. Check the model and version of the Communicator.</li> <li>2. Check if there is a problem with the power supply.</li> </ol>	<ol style="list-style-type: none"> <li>1. Use a handheld communicator that supports the HART protocol (Rosemount 275, 375, 475);</li> <li>2. Replace the power supply;</li> <li>3. Change the safety barrier, or string 250 ohm resistor.</li> </ol>
---	--	--

## 10 Disassembly

### 10.1 Warning

Attention should be paid to hazardous process conditions, such as pressure inside the vessel, high temperatures, corrosive or toxic media, etc.

Refer to the instructions in section 6.3 Installation Operation and Section 7.2 Electrical Wiring to remove the parts in the reverse order of operation.

### 10.2 Waste Removal

Waste disposal should be carried out in accordance with the current guidelines in each region.

## 11 Product Certification